

# The Context of Living Machine Wastewater Treatment Technology and

## Documenting its Start-up at Oberlin College

Varuni Tiruchelvam

May, 2000

### Advising Committee:

David Benzing - Biology, Environmental Studies

John Petersen - Environmental Studies, Biology

David Orr - Environmental Studies, Politics

### Table of Contents

Abstract	1
Introduction	1
Chapter 1: Global Water Pollution	2
Properties of Wastewater	4
Chapter 2: Conventional Wastewater Treatment	5
Primary Treatment	6
Secondary Treatment	7
Sludge Thickening	10
Advanced Tertiary Treatment	12
Government Standards and Regulations	13
Chapter 3: Sewage Treatment for the AJLC	14
The Living Machine at Oberlin College	15
Structural Design Problems	22
Communication Problems	24
Start-up Procedure	26
Monitoring	31
Maintenance	33
Chapter 4: Research Topics	34
Literature Cited	36
Best Performing Plants	Appendix A
Plant Species in the Greenhouse	Appendix B

Common Problems and Solutions

Appendix C

# The Context of Living Machine Wastewater Treatment Technology and Documenting its Start-up at Oberlin College

Varuni Tiruchelvam

May 2000

## **Abstract**

Information about context of living machine wastewater treatment and the machine's start-up concerns needs to be conveyed to people who operate, research, or want to purchase living machines.

Life, not chemicals and extracting machinery, cleans the wastewater in the living machine, and engineered components make up the structure of the system. Design oversights, which occurred during planning and construction, affect treatment and complicate operating procedures. Under-utilization of the toilets, the overriding problem, stresses the machine's organisms, which rely on sewage for their nutrients. Despite many concerns, Oberlin's Living Machine is an excellent tool to educate visitors and to give students hands-on experience with ecological design. The living machine has tremendous potential for useful student research.

## **Introduction**

Water pollution is a worldwide problem, yet the numerous wastewater treatment methods, such as composting toilets, wetlands, living machines, and conventional sewage treatment plants, can reduce or eliminate fecal contamination of waterways. Energy intensive machinery and chemical coagulants govern the conventional sewage treatment process. Although the living machine was not a necessary sewage treatment solution for the Adam Joseph Lewis Center for Environmental Studies, the machine serves as a visual demonstration that designs can go one step ahead of conventional wastewater processing and make sewage treatment beautiful.

This document was created for people who will operate the living machine, research oriented students, and people interested in purchasing a living machine. The context for living machine wastewater treatment technology is global water pollution (Chapter 1) and the

conventional method of cleaning fecal matter from water (Chapter 2). The living machine contains similar technology to conventional treatment, but the bacteria and plants in the living machine eliminate the need for much of the large, ugly equipment in conventional treatment. This document then provides information on Oberlin's living machine sewage treatment (Chapter 3), design and construction concerns, the start-up procedure, operations and maintenance, and future research topics (Chapter 4).

### **Chapter 1: Global Water Pollution**

Clean water is vital to life, yet we irresponsibly use it as a vehicle to transport waste. Thousands of municipal, industrial, and agricultural pollutants flow into rivers and lakes. Failure to treat wastes at their source causes myriad social, medical, and environmental problems. Polluted water causes 26,000 human deaths every day (Young, et al. 1994). In 1994, 1.7 billion people (over 1/3 of the world's population) lacked access to safe drinking water, and 1.2 billion lacked adequate sanitary facilities (UNEP). Contaminated water causes 80% of the diseases and 1/3 of the deaths in developing countries; on average, one-tenth of a person's productive life is sacrificed to water-related illnesses (Young, et al. 1994).

According to the World Health Organization, fecal coliform counts, which are used to monitor sewage pollution, should be zero for drinking water and should not exceed 10/100 ml in water for domestic use and bathing. The EPA recommends no more than 200/100 ml in swimming water. In 1982, Yamuna River water entering New Delhi contained 7500 fecal coliforms per 100 ml and 24 million/100 ml as it flowed out of the city (UNEP 1991). New Delhi dumps 200 million liters of raw sewage into the Yamuna River every day, yet its poor citizens use river water exclusively. Two-thirds of India's water resources are severely polluted, and only 217 of its 3,119 municipalities have any type of sewage treatment. Of these, only 8 have modern facilities (Miller 1998). Ninety-eight percent of the urban sewage in Latin America is discharged untreated into the nearest waterway or lagoon (Miller 1998). Eighty-five percent of China's urban sewage receives no treatment (Miller 1998). Eighty-five percent of the sewage

from the 200 million urbanites living along the Mediterranean coastline flows untreated into the sea (Miller 1998).

Fecal contamination has devastating medical impacts. Both the polio virus and the hepatitis A virus are feco-oral (they are spread by ingesting fecal matter). Feco-oral bacteria cause the largest number illnesses. These diseases, which include dysentery, typhoid fever, cholera, induce diarrhea, which spreads the bacteria further. In 1993, 1.8 billion people contracted diarrhea-causing diseases, and 3 million children under the age of 5 died from them (Platt 1996). In 1991, an outbreak of cholera in Peru spread to every country in Latin America and affected 500,000 people before subsiding two years later. People who swim in polluted water risk infection by parasites. Two hundred million people currently suffer from schistosomiasis. The condition is characterized by cirrhosis of the liver, intestinal and urinary tract damage, and anemia. Another common disease contracted by living near polluted waters is onchocerciasis, or river blindness. The parasite, which is carried by a blackfly that breeds in slow-moving rivers, affects about 18 million people in western Africa. Severe lesions form around the eyes, and about one in tenth victims becomes blind.

Environmental and social problems arise from the lack of clean water. Households in Jakarta, Indonesia spend \$50 million a year on wood and fuel to boil contaminated water, thereby increasing deforestation and air pollution (Platt 1996). Governments fail to provide clean water to those who suffer the most. Squatters and poor citizens who live on the outskirts of planned developments have little access to publicly sanitized water, so they must pay private vendors extraordinary prices for water. Squatters in Dhaka, Bangladesh must pay 12 times the municipal water rate. In Lima, Peru, poor people pay \$3 a cubic meter for water, which they collect using an unsanitary bucket, while rich pay 30 cents per cubic meter for water that is piped into their homes.

The nutrients in contaminated water also cause eutrophication, which leads to blooms of algae, cyanobacteria, water hyacinths, and duckweed. Dissolved oxygen levels drop as algae and plants die and are decomposed by aerobic bacteria. The water body becomes discolored and

acquires an unpleasant odor as fish die from lack of oxygen and as anaerobic decomposing bacteria emit gases, such as hydrogen sulfide. Eutrophication occurs in a large percentage of water bodies: 54% in Asia and the Pacific, 53% in Europe, 48% in North America, 41% in South America, and 28% in Africa (UNEP 1994).

Poor water quality continues to be a problem for countries that have been industrially developed for several decades. Seventy-five percent of the rivers in Poland contain water that is too polluted for industrial use (UNEP 1991). Forty-four percent of lakes, 37% of rivers, and 32% of estuaries in the United States are too polluted for recreation (Miller 1998). The United States still discharges 35% of all municipal sewage untreated into oceans (Miller 1998).

Note: According to UN plan, safe drinking water could be supplied to all people at an annual cost of \$15 billion (Young, et al. 1994). One and a half billion dollars was spent. The world spends \$15 billion every 5 days for military purposes.

### **Properties of Wastewater**

Water exposed to municipal, industrial, and agricultural wastes is contaminated with organic compounds, pathogens, and toxins. Numerous criteria, including BOD, COD, MLSS, TSS, DO, nitrogen, phosphates, and temperature, are used to measure water quality.

### **Sewage Treatment Terminology:**

**BOD** - Biochemical Oxygen Demand - the amount of oxygen that a mixed population of aerobic microorganisms uses to oxidize a given amount of organic carbon at 20°C over a specified interval.

**DO** - Dissolved Oxygen

**ORP** - Oxidation-Reduction Potential – ORP, which is measured in millivolts, gives information on which terminal electron acceptor is being used in the Krebs cycle. The free energy hierarchy of terminal electron acceptors ranks O<sub>3</sub> with an ORP of above +500 mV, O<sub>2</sub> (aerobic conditions) between +50 and +500 mV, and NO<sub>3</sub> (anoxic conditions) between +50 and –150mV.

Below  $-150$  mV, anaerobic conditions exist and sulfate is used.

**MLSS** - Mixed Liquor Suspended Solids - the suspended community of microbial species that consume dissolved wastes in the aerated (mixed) tanks.

**TSS** - Total Suspended Solids - the amount of solids suspended in the water.

**gpd** - gallons per day - units for measuring wastewater flow

**psi** - pounds per square inch - units for measuring air pressure generated by the air blowers

**cfm** - cubic feet per minute - units for measuring airflow into the diffusers and airlifts

## **Chapter 2: Conventional Wastewater Treatment** (Hammer and Hammer 1996)

The first modern wastewater treatment design involved sedimentation in two-layered septic tanks. Sedimentation occurred in the upper zone and sludge digestion occurred in the lower chamber. The digested sludge was periodically withdrawn for disposal. Sedimentation treatment alone was ineffective at cleaning water because half of the organic particles in wastewater do not settle readily, and using chemicals to coagulate the particles was expensive. Secondary treatment using gravel beds, also called trickling filters, began in 1910. Microbes residing on the gravel oxidize the organic matter in the wastewater. Sewage treatment was further advanced with the discovery that microbes can flocculate organic particles (floc-forming microbes cause particles to stick together in clusters). In the 1920's, the first continuous-flow treatment plants began using floc-forming microbes, also called activated sludge, to remove organic particles from wastewater.

Modern sewage treatment occurs in several stages (Figure 1). Pretreatment involves screening through 1-inch bar openings to remove large solids. Water passes through a grit chamber, which withdraws the fine sand particles that cause abrasion on mechanical equipment. Primary treatment removes surface floating scum and the organic matter that settles (30 to 50 percent of the TSS). Secondary treatment involves trickling filtration, or activated sludge treatment (floc-forming microbes in mixed tanks), and finally clarification. The settled sludge from the clarifier is recycled or discharged, and the supernatant is chlorinated and then diluted in

a river or lake. The discharged sludge is thickened and dewatered for use as agricultural fertilizer or for disposal in a landfill or incineration.

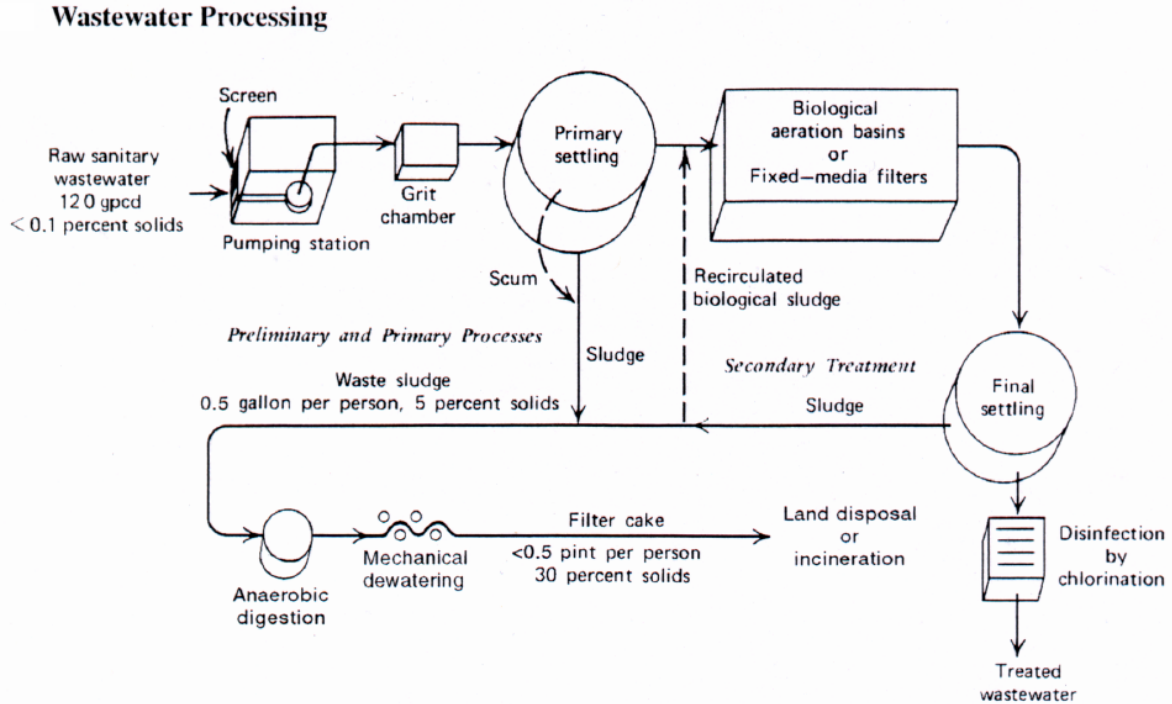

Figure 1 Schematic of a conventional municipal wastewater treatment plant. Floating, settleable, and biologically flocculated waste solids are removed from the water, stabilized, and dewatered for ease of disposal. (Hammer and Hammer 1996)

**Primary treatment:**

The daily production of raw sanitary water flowing into treatment plants in the United States averages 120 gallons/person and contains solids at < 0.1%, suspended solids of 240 mg/l, and a BOD of 200mg/l (Hammer and Hammer 1996, p. 352). Primary settling (Figure 2) reduces the density of septic sludge. A baffle dissipates influent velocity to create quiescent conditions in the settling tank. A slow conveyor arm on the tank floor moves the settled sludge into a disposal hopper. Water exits through surface weirs near the effluent pipe, and floating sludge is collected by a baffle near the weirs.

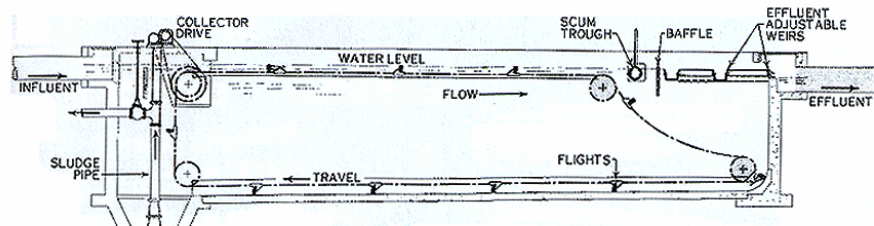
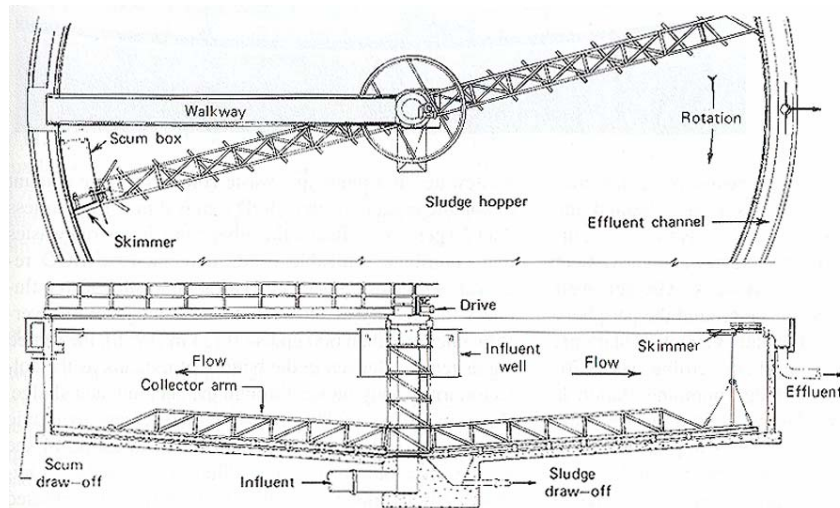

Figure 2 Longitudinal section of a rectangular, primary settling tank. Sludge collector scrapes settled solids to hopper at inlet end. The upper run of flights pushes floating matter to a scum trough. (Courtesy of FMC Corp., Material Handling Systems Div.) (Hammer and Hammer, 1996)



The primary clarifiers (Figure 3) function similarly, but have a more advanced skimming device and multiple effluent weirs. Although an arm for bottom sludge collection is still present, the tank bottom usually slopes at an 8% gradient toward the sludge-collection hopper.

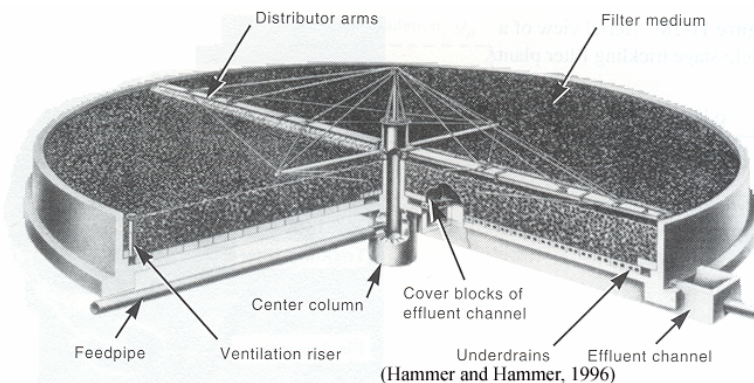

**Figure 3** Circular primary clarifier with a pier-supported center drive and peripheral effluent weir. (Courtesy of Welles Products Corp.) (Hammer and Hammer, 1996)

### Secondary treatment:

Secondary biological treatment utilizes biological filtration (trickling filters) or activated sludge. Raw wastewater is sprayed over the fixed matrix in the trickling filter (Figure 4), and a slime of bacteria, protozoa, fungi, algae, rotifers, sludge worms, and fly larvae develops on the matrix.

**Figure 4** Cutaway view of a stone-media trickling filter.



The biological layer is aerobic near the surface and anaerobic below. Bacteria are the primary consumers in the system, and rotifers and protozoa then graze on the algae and bacteria. The

matrix is composed of crushed rock or of plastic designed to have the maximum surface area for slime. The filter must be occasionally purged to maintain its porosity to water and air. Flies and odors, from anaerobic sulfur reduction ( $\text{organics} + \text{SO}_4^{-2} \Rightarrow \text{CO}_2 + \text{H}_2\text{S} + \text{energy}$ ), are also problems associated with trickling filters.

Bacteria of the genera *Alcaligenes*, *Flavobacterium*, *Bacillus*, and *Pseudomonas* dominate activated sludge. The bacteria exude a polysaccharide matrix, which permits them to flocculate organic particles. The bacteria collide with other particles in a well-mixed waste stream and form clusters called “flocs.” The flocs of bacteria can settle in the clarifier, whereas solitary cells cannot. DO must be maintained between 0.2 and 2.0 mg/l to permit aerobic metabolism. Air is supplied through ceramic diffusers located on the bottom of the tank or attached to pipes at a depth exceeding 8 ft (Figure 5).

**Figure 5** Cross-sectional diagram illustrating the operation of a typical small extended aeration plant with diffused aeration and an air-lift pump for return of settled solids and scum to the aeration tank.

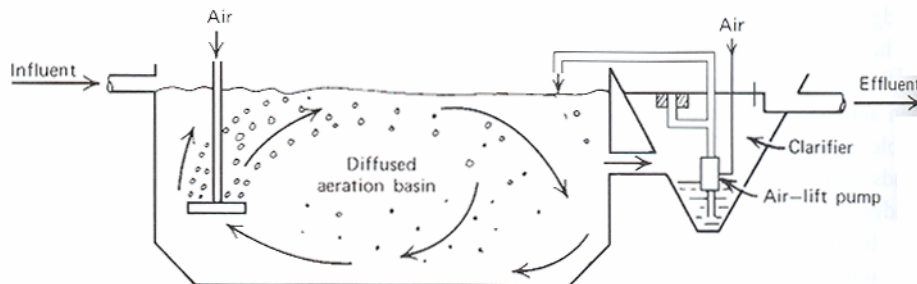

(Hammer and Hammer, 1996)

The mixed microbial culture of bacteria and protozoa metabolizes organic matter ( $\text{organics} + \text{O}_2 \Rightarrow \text{CO}_2 + \text{H}_2\text{O} + \text{energy}$ ), thereby taking dissolved organic matter out of solution (microbial cells + dissolved organic matter +  $\text{O}_2 \Rightarrow$  more microbial cells +  $\text{O}_2 + \text{H}_2\text{O}$ ). The protozoa enhance treatment by consuming the solitary bacteria that do not settle in the clarifier.

Merely aerating  $20^\circ\text{C}$  wastewater reduces organic matter by 70% in 5 days.

Incorporating principles of mass-driven kinetics into a recycle loop speeds up the treatment process. Mass-driven kinetics state that a large initial population metabolizes food faster than a small population. Figure 6 depicts how mass driven kinetics influences the metabolic rate. A quantity of organic matter ( $y_1=y_2$ ), represented by a change in BOD, is metabolized more quickly ( $x_1 < x_2$ ) when the initial organic load is high; therefore, organic matter is reduced by

70% in a only few hours if the mass of settled microbes from the clarifier are recycled back to the first aerobic tank.

**Figure 6**

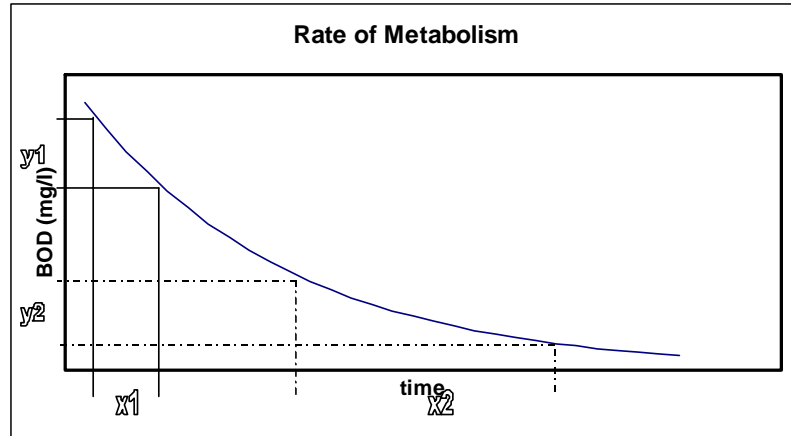

Treatment is enhanced by storing the settled sludge from the clarifier until the bacteria enter an endogenous (starvation) phase. Because they lack food, the microorganisms in an endogenous phase “metabolize their own protoplasm” and produce no new cells (Crites and Tchobanoglous 1998, p. 410). These starved microbes consume wastes rapidly when they are recycled back to the aerobic tanks.

The food-to-microorganism ratio (F/M, expressed in pounds of BOD in the influent per pound of MLSS in the aeration tank) also effects treatment. A high F/M ratio results in incomplete metabolism of organic matter, and poor settling of the biological floc. Starved microorganisms quickly metabolize organics if the F/M ratio is low (between 0.2 and 0.5).

The clarifier operates on the same basic design as the primary settling clarifiers but it must be able to handle the greater volume of floating sludge from aerated treatment. Sometimes a rapid-sludge-removal clarifier has additional suction pipes attached to the lower arm (Figure

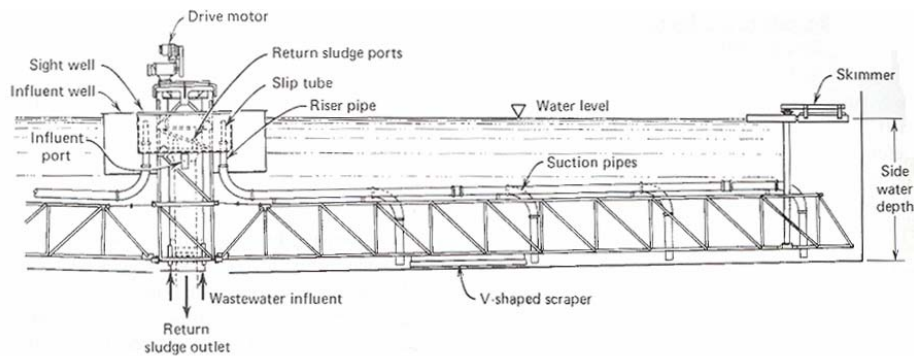

**Figure 7** Final clarifier designed for use with biological aeration. Activated sludge is withdrawn through suction (uptake) pipes that are located along the collector arm for rapid return to the aeration basin. Sludge flowing from each pipe can be observed in the sight well. (Courtesy of Walker Process Equipment, Division of McNish Corporation.) (Hammer and Hammer, 1996)

7). The increased removal of the settled sludge results in less floating sludge buoyed up by  $N_2$  gas (a product of denitrification, which can occur in anaerobic zones within the settled sludge).

Chlorination constitutes the final step during secondary treatment. Disinfection must reduce the number of fecal coliforms in secondary effluent (100,000 to 10,000,000/100ml) to less than 200/100ml. Chlorine inactivates pathogens by disrupting cell permeability and damaging nucleic acids and enzymes. Chlorine is injected into the secondary effluent either as the water flows rapidly through a pressurized pipe or before water enters a mechanical mixer. Because the chlorine must contact the water for a minimum of 20 to 30 minutes, the treated water flows into a plug-flow basin (a tank with a plug that temporarily stops effluent flow) or a long, narrow chamber to slow flow and to minimize the backmixing that would occur in a circular or rectangular tank. Some regulations limit residual chlorine in the undiluted effluent to between 0.1 and 0.5 mg/l to reduce toxicity to wildlife; therefore, treatment facilities may use sulfur dioxide for dechlorination.

### **Sludge Thickening:**

A conventional treatment plant concentrates the solids in 100 gallons of wastewater into 0.5 gallons of sludge; therefore, a treatment plant must dispose 5000 gallons of sludge for every million gallons of water it treats. One-third of the monetary investment in a sewage treatment plant is required to stabilize, dewater, and dispose the sludge.

Anaerobic sludge digestion (Figure 8) converts “bulky, odorous, raw sludge in to a relatively inert material that can be rapidly dewatered with the absence of obnoxious odors.” Acid forming bacteria convert organic matter to  $CO_2$ ,  $CH_4$ ,  $H_2S$ , and organic acids. Then methane forming bacteria convert the organic acids to  $CO_2$  and  $CH_4$ .

**Figure 8** Diagram of a single-stage floating-cover anaerobic digester.

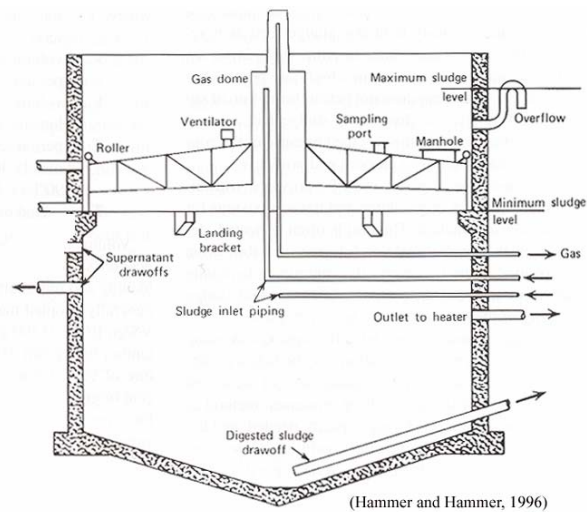

A variety of methods dewater liquid waste sludge, which is 5 % solids by weight, into a cake which has a 30 % solids concentration. The belt filter press (Figure 9) is the most common.

A belt filter press compresses the sludge layer between two rolling belts.

**Figure 9** Operational diagram and photograph of a belt filter press with two continuous belts for gravity and pressure dewatering with uniform-diameter rollers. (Courtesy of Ashbrook Corporation.)

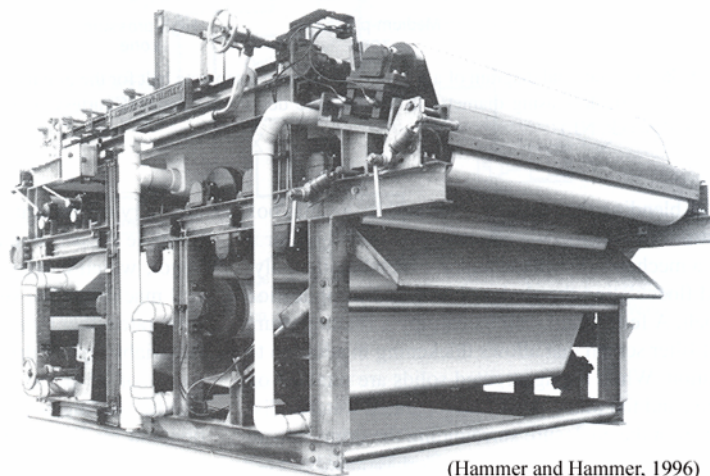
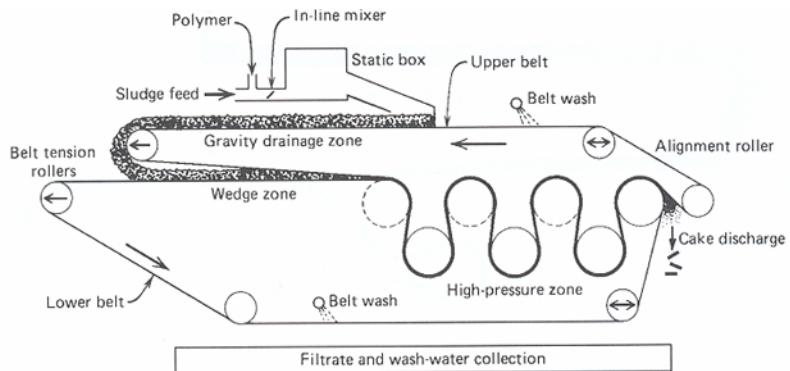

Sludge is spread to a depth of 12 inches on drying beds (Figure 10). Liquid filters through the layers of sand and gravel to drainage pipes, and the sludge dries into a black cake 3 to 5 inches thick.

**Figure 10** Open-air beds for drying digested sludge with paved surfaces to allow mechanical removal of dried cake. Water is separated by decanting supernatant, draining to trenches, and evaporation. (Courtesy of HDR Engineering, Inc.)

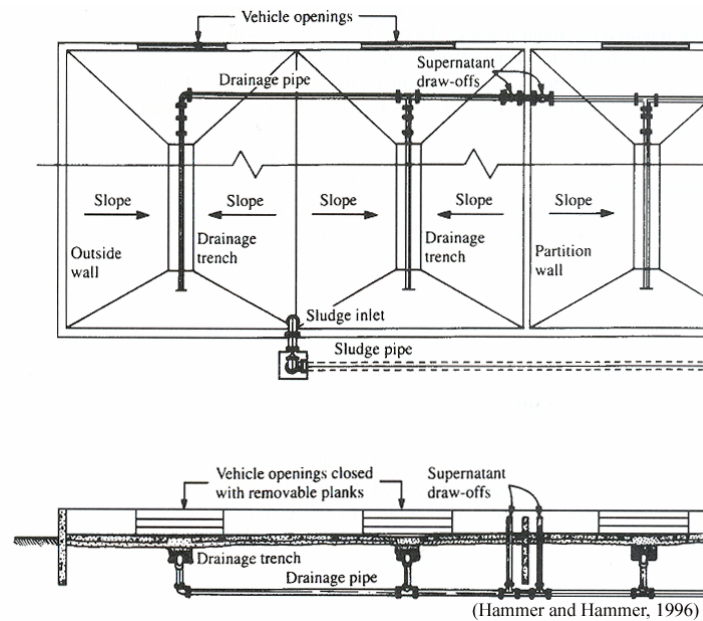

### Advanced Tertiary Treatment:

Advanced treatment, also known as tertiary treatment, commonly involves disinfection, nitrification, denitrification, and the removal of phosphorus. Water is rapidly mixed with coagulation chemicals, like alum, and then filtered through a sand-coal medium to reduce the suspended solids to less than 10 mg/l. Filtering the water before an extended chlorination interval of 90 minutes removes suspended solids that interfere with disinfection.

Secondary treatment removes only 20 to 40 % of the phosphorus, reducing its concentration from 7 to 5 mg/l. Chemical treatment, which uses aluminum or iron salts to precipitate phosphorus, and biological processing in tertiary treatment further reduce levels to 1.0 mg/l. A 90% reduction in phosphorus is economical if iron salts in waste pickle liquor from

the steel industry are used. The chemicals are added directly to the biological process, prior to clarification.

Bacteria in secondary treatment convert organic nitrogen to ammonia, which is toxic to aquatic animals at concentrations above 5mg/l. Wastewater contains an initial organic nitrogen concentration of 35 mg/l, and concentrations of organic nitrogen at 2 mg/l and ammonia at 24 mg/l remain in the effluent after secondary treatment. Nitrifying *Nitrosomonas* and *Nitrobacter* are chemoautolithotrophs that require free oxygen to oxidize the inorganic nitrogen compounds for energy and use CO<sub>2</sub> as their carbon source for growth and reproduction. (Most autotrophs gain energy from sunlight, not from chemicals). Nitrifying bacteria convert ammonium to nitrate in a two step process:  $\text{NH}_3 + \text{O}_2 \Rightarrow \text{NO}_2^- + \text{energy}$ , then  $\text{NO}_2^- + \text{O}_2 \Rightarrow \text{NO}_3^- + \text{energy}$ . Nitrification could occur during secondary treatment in activated sludge at warm temperatures and low organic loading, but in colder water temperatures, separate tertiary treatment must be used. Although a more stable effluent results, biological nitrification can be undesirable because of its high oxygen demand and because bubbles of N<sub>2</sub>, which result from simultaneous denitrification, create floating sludge.

Denitrification by facultative heterotrophic bacteria requires an anoxic environment and a carbon source. As bacteria use nitrate as the terminal electron acceptor in the electron transport chain, they convert it to nitrogen gas ( $\text{NO}_3^- + \text{organic matter} \Rightarrow \text{N}_2 + \text{oxidized organic matter}$ ). Methanol can be applied as a carbon source because it does not leave BOD in the effluent ( $\text{CH}_3\text{OH} + \text{NO}_3^- \Rightarrow \text{N}_2 + \text{CO}_2 + \text{H}_2\text{O} + \text{OH}^-$ ), but it is expensive. A cheaper alternative uses residual BOD as the carbon source for denitrifying bacteria. The combination of biological nitrification and denitrification removes 50 to 60 % of the nitrogen.

### **Government Standards and Regulations**

The national pollutant discharge elimination system (NPDES) mandates secondary biological treatment for wastewater and supplies basic effluent standards. Effluent samples are collected downstream from the discharge outlet. NPDES specifies that BOD and suspended

solids may not exceed a 30mg/l average for 24-hr composite samples taken over 30 consecutive days. Values for any 7-day interval may not exceed 45 mg/l. At least 85% of the BOD and suspended solids must be removed. The average concentration of oil and grease must not exceed 10 mg/l over a 30-day interval nor 20 mg/l over a 7-day interval. Effluent pH must remain within 6.0 - 9.0.

The EPA requires various technological components in sewage treatment facilities. Best Conventional Pollutant Control Technology (BCT) requires controlling conventional pollutants with secondary treatment, pre-treating toxic wastes at industrial sites, and, if necessary, chlorinating the effluent to reduce microbial populations. Best Available Technology Economically Achievable (BATEA) sets standards for toxin and non-conventional pollutant control according to the individual plant owner's ability to afford the technology, not according to the environmental costs and benefits of pollution reduction. Tertiary chemical coagulation, granular-media filtration, and chlorination to remove all pathogens are examples of BATEA.

### **Chapter 3: Sewage Treatment for the Adam Joseph Lewis Center**

The Adam Joseph Lewis Center for Environmental Studies does not need a living machine because the Oberlin municipal sewage line runs along the east side of the building. The living machine was installed to fulfill the design criteria of the building (“treat all wastes on-site”) and for its tremendous educational value. Closed-mindedness and society's general discomfort with talking about fecal matter prevented the design team from installing composting toilets, the ideal, low-tech, sewage treatment solution. Administrators would not allow the Lewis Center to be built unless it had flushing toilets.

Another low-tech sewage treatment option, the constructed wetland, uses aquatic plants, bacteria, animals, and physical processes, like precipitation and mechanical straining, to treat wastewater. The treatment wetland consists of a planted basin with natural or constructed impermeable liner, and wastewater fills this marsh or swamp to a depth of 4 to 18 inches (Crites and Tchobanoglous 1998). The Lewis Center could not use an outdoor constructed wetland



because discharging unchlorinated water to the surface is illegal, wetlands require a large area, and treatment slows greatly in the winter when the vegetation dies. The living machine takes the wetland into a greenhouse and contains wetland life processes within the structures of conventional treatment.

### The Living Machine at Oberlin College

While conventional treatment is designed to concentrate waste for disposal, living machines are designed according to John Todd's ecological design principle, "Waste equals food." The sewage passing through the living machine serves as nutrients for microbes, animals, and plants. Wastewater receives advanced tertiary treatment without the use of chemicals. Estimated flow is 2470 gallons per day with a BOD of 300 mg/l.

Figure 11

### PROCESS FLOW SCHEMATIC A LIVING MACHINE FOR THE ENVIRONMENTAL STUDIES CENTER OBERLIN COLLEGE

(Operation and Maintenance Manual  
Living Machine for Oberlin College, 2000)

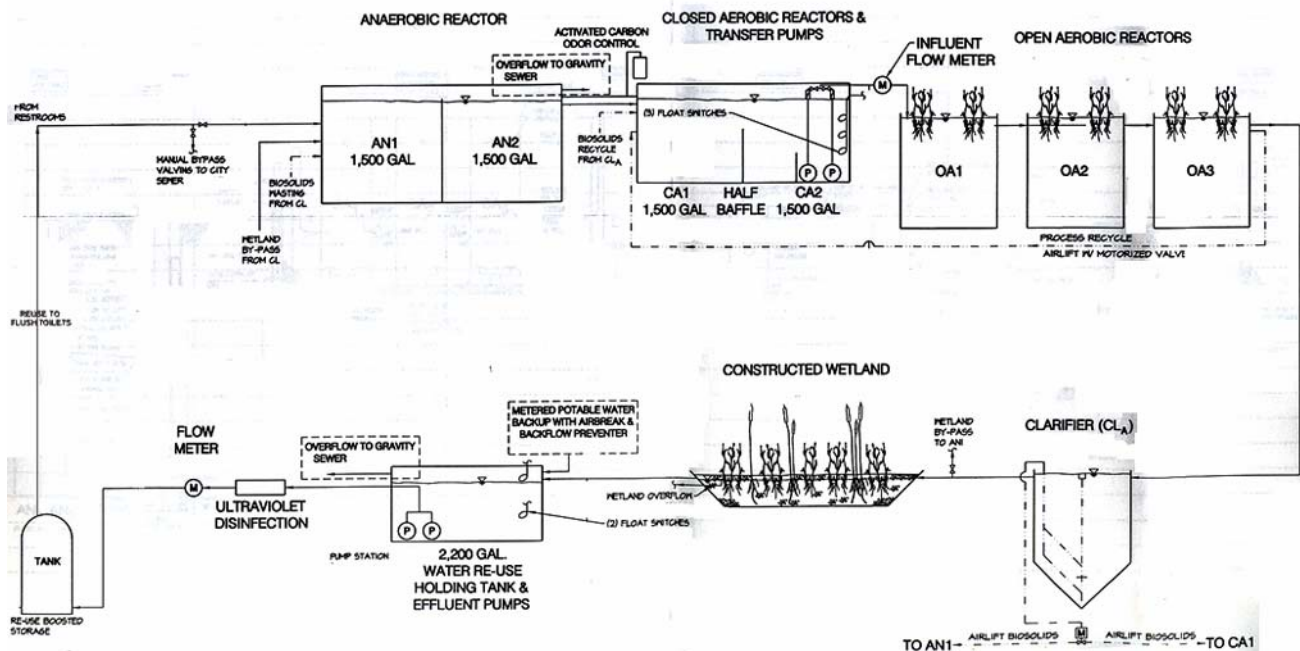

The first valve in the Oberlin's living machine (see Figure 11) is a below-grade bypass

valve directing the wastewater flow into the machine or the city sewer. Raising the east lever opens the knife valve which allows wastewater from the 5 toilets, 1 urinal, and 5 sinks to flow by gravity into the **anaerobic tanks, AN 1 and 2**, (Figure 12) located below grade on the east side

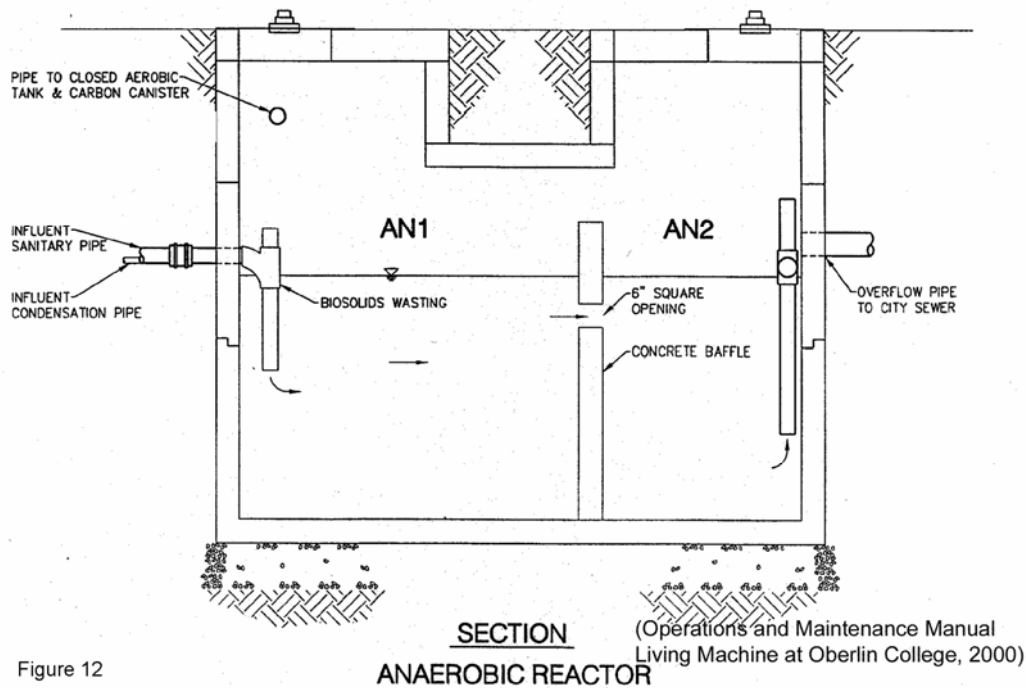

Figure 12

of the Lewis Center.

Water remains under anaerobic conditions for 1.2 days, and a slotted baffle dividing the two tanks prevents floating fats from flowing through untreated. Large particles settle in **AN 1** before the baffle. Hydrolysis and fermentation break down the large organic particles into compounds that bacteria metabolize. Then acid-forming bacteria (organics  $\Rightarrow$  organic acids +  $\text{CO}_2$  +  $\text{H}_2\text{O}$  + energy), and methane-forming bacteria (organic acids  $\Rightarrow$   $\text{CH}_4$  +  $\text{CO}_2$  + energy) complete the anaerobic digestion. The inefficiency of anaerobic respiration greatly enhances the treatment process. Anaerobic bacteria produce only 6 ATP per molecule of glucose instead of the 26 ATP produced during aerobic respiration; therefore, after using 4 ATP for life processes, little energy remains to support reproduction. Anaerobic bacteria consume 50% of the influent's

organic waste while adding very few new cells to the water.

Following anaerobic digestion, the wastewater flows by gravity to the **closed aerobic**

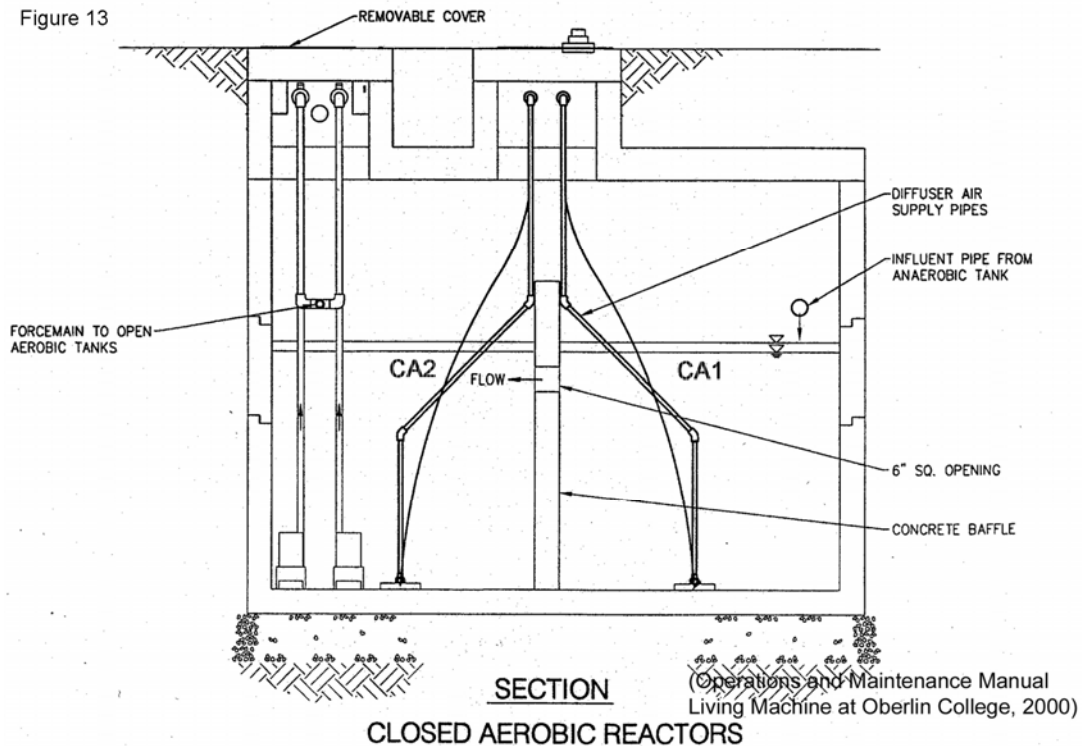

tanks, CA 1 and 2 (Figure 13).

The closed aerobic tanks function as in conventional activated sludge treatment. Diffusers supply air to the bottom of the tanks to encourage the growth of aerobic heterotrophic microbes, which rapidly consume organic matter. Aeration also drives off odor-producing anaerobic bacteria, and their gaseous products are captured with a carbon filter. A half baffle divides the two tanks. Within 1.2 days, BOD has diminished 90%.

Wastewater in CA 2 and triggers a middle float that engages the pumps. Under normal conditions, two **pump stations, PS1 and PS2** (located on the bottom of CA2), alternate to pump the water, but if the water level rises to the high alarm float, both pumps will activate. Water is sent into the open tanks inside the building until the water level falls below a low float that

switches the pumps off. A small vertical distance between the middle “pump on” float switch and the low “pump off” float switch minimizes the pumping time and the resulting flow peak in the open tanks. Because flow meters require a pressurized line, the influent flow meter is located along the pipe from CA 2 to OA 1, the first pressurized flow in the system. The **influent flow meter** is magnetic. Its coils generate a magnetic field around the flow tube, and flow through the tube generates an electric current proportional to the flow volume. The LCDs (liquid crystal displays) which show flow rate and total flow volume are located in the pump room.

If CA 2 has received sufficient aeration, water entering the **open aerobic** tanks should contain a very little organic matter and produce no strong odors. Wastewater enters **OA 1** (located at the west end of the greenhouse) and flows by gravity to **OA 2 and OA 3**. Several processes occur in the open tanks. Aerobic heterotrophic bacteria consume the remaining organic matter. As the nutrient concentration decreases, the heterotrophic population declines, and a population of chemoautolithotrophs dominates the microbial community. These organisms nitrify the ammonia and begin the advanced tertiary phase of sewage treatment.

“Grazing,” an additional treatment process in the open tanks, involves predation by protozoans, rotifers, copapods, and nematodes. According to David Austin, the head of operations at Living Technologies, the living machine is 80% conventional sewage treatment technology, but the grazing community makes the living machine an outstanding innovation (2000). Floating racks in the OA tanks hold plants, which have a large root surface area to provide a substrate for grazers. As well as clarifying the water, the grazers begin disinfection by consuming solitary bacteria, termed “single-celled bacteria” (all pathogens are single-celled). The highly diverse group of organisms attached to roots makes the living machine a more stable biological system than conventional treatment. Many grazers are able to crawl up the roots to survive at the air-water interface when wastewater becomes too concentrated; therefore, the living machine can tolerate shocks that would kill all the wastewater organisms in conventional activated sludge treatment.

After water has been in the three OA tanks for 1.8 days, it flows by gravity into the **clarifier** (Figure 14).

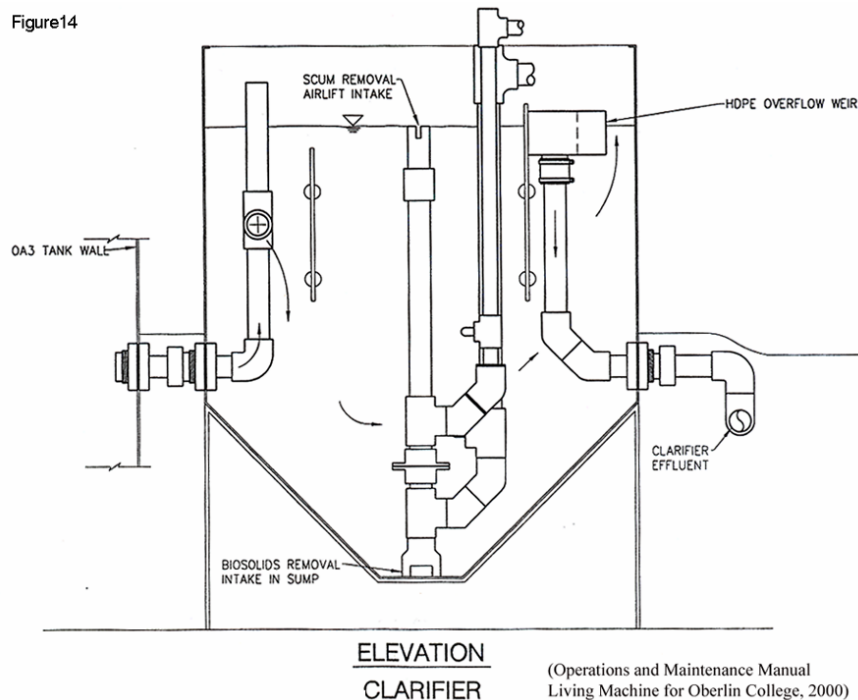

Several components reduce turbulence to allow the remaining solids to settle. Water enters the clarifier through a long slot in a horizontal header pipe, which dissipates influent velocity and to distributes flow across the width of the tank. A vertical baffle near the inlet pipe also slows water flow and encourages settling.

Sewage contains three forms of bacteria, single-celled, filamentous, and floc-forming. Floc-forming bacteria settle on the clarifier's cone-shaped bottom. After a treatment time of 0.2 days, supernatant flows under a baffle, which retains floating matter in the tank, and over another baffle. The long, slightly slanted overflow baffle slows flow (fast flowing effluent would create an upflow that would lift settled sludge). Because water flows by gravity through all of the open tanks, the height of the overflow baffle determines the water height in all of the them. The

supernatant flows into a vertical pipe in the center of the baffles and moves into the wetland sump.

Because nitrogen bubbles in the settled solids sometimes lift portions of the sludge blanket to the surface, an airlift periodically sucks floating solids into a centrally located surface scum drain. Another airlift removes settled sludge from the apex of the clarifier cone. All of this airlifted waste flows through a 3-way motorized ball valve that directs the flow to CA1 or to AN1. Sludge moves by gravity through a pipe to CA1, or the sludge can be directed to AN1 via the PLC if it becomes anaerobic or accumulates above two feet. The airlifted surface water and scum flow by gravity to AN 1.

Only floc-forming bacteria settle, but single-celled and filamentous bacteria have the competitive advantage because they can more readily access food (To enter solitary bacteria, food must only pass through a thin cell membrane instead of through the additional polysaccharide matrix surrounding the flocs. Filamentous bacteria are long and thin and therefore have a large surface area available for absorption). Dense populations of single-celled and filamentous bacteria cause problems in wastewater treatment plants and especially in living machines where no chemicals are added to enhance flocculation and settling. The clarifier will not function because single-celled bacteria do not settle in water, as a grain of rice will not sink in honey. Filamentous bacteria, which are single cells enclosed in long fatty sheaths, float on the surface. Aeration causes some species of filamentous bacteria to form a sticky foam that will suffocate the plants. Uncontrolled filamentous bacteria can form foam mounds that rise many feet above the wastewater tanks and can easily be blown out of the tanks, potentially spreading pathogens.

Three strategies are used to inhibit single-celled and filamentous bacteria, thereby allowing floc-formers to dominate the system. The grazing function of the root-zone community greatly reduces the numbers of single-celled bacteria. A recycle flow from OA3 to CA1 at three times the influent rate (about 9000 gpd), controls filamentous bacteria, which are obligate aerobes and cannot tolerate the anoxic conditions of CA1 (The OA3 recycle flow also sends

nitrified water back to CA1 where facultative denitrifiers convert the  $\text{NO}_3$  to  $\text{N}_2$ ).

Aeration circulates water in CA1 but the air supply is too low to support aerobic metabolism. A DO of less than 0.4 mg/l creates anoxic conditions where organisms begin to use nitrate as the terminal electron acceptor in the Krebs cycle. Obligate aerobes only produce oxygenase and they die in anoxic conditions. The anaerobic water that flows into CA1 maintains anoxic conditions. The floc-forming bacteria outcompete other bacteria because they are recycled from the clarifier floor to CA1. Floc-forming bacteria are facultative aerobes that produce both oxygenase and nitrogenase and can switch from aerobic to anaerobic respiration in 2 to 6 hours; therefore the floc-formers begin to metabolize and reproduce before the other bacteria can grow. The same ecological principles govern both living machine wastewater treatment and activated sludge treatment (mass driven kinetics and the endogenous growth phase of settled sludge affect metabolism). A low organic load in the open tanks and an extended sludge settling interval in the clarifier allow the bacteria to enter an endogenous phase in the absence of a sludge holding tank, which is present in conventional treatment.

Under normal operating conditions, the supernatant from the clarifier flows into the below grade wetland sump (however, plugging the inlet to the sump and releasing a knife valve, located in a below grade box to the north of the sump, bypasses the wetland system and directs water to AN1). From the sump, water enters the **wetland** through an underground, perforated pipe that spans the east end of the greenhouse. Caps, which can be removed for pipe cleaning, mark the ends of the pipe. Different sizes of gravel (1/10 - 1 1/2" washed crushed stone on the surface, 1/2 - 2" washed crushed stone in the central treatment zone, and 2 - 4" washed rock in

Figure 15

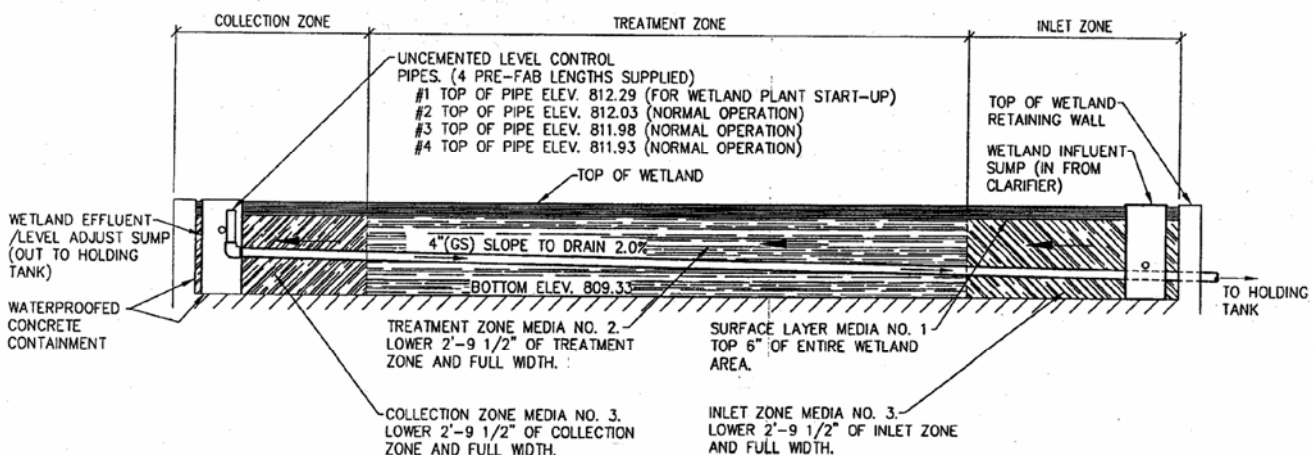

distribution and collection zones) fill the three-foot deep bed (Figure 15). Local wetland plants grow in the central treatment zone.

Water requires 0.7 days to flow from the east to the west side of the greenhouse through the gravel bed. Anaerobic heterotrophic bacteria, which acquire carbon from leaky roots and decomposing plant material, begin denitrification and consume the residual dissolved carbon. Roots also take up phosphorous, an essential nutrient for plants. A wetland overflow riser (a wide, mesh-covered standpipe at surface level) prevents water from flowing above the gravel. The perforated collection pipe runs along the west side of the wetland. An overflow standpipe, which can be replaced with different lengths of pipe, in the collection sump controls the water level in the wetland.

Water flows down the standpipe to an underground **water re-use holding tank** outside the building. The water in this holding tank either overflows to the sewer or reenters the flush toilets. When the **boosted storage tank** (used to pressurize flush water) requires more water to create a minimum pressure of 30 psi, the PLC turns on the pumps until the pressure reaches a maximum of 50 psi or until low water triggers the “pump off” float switch. The **pump stations, PS3 and PS4**, alternate to pump water to the boosted storage tank inside the building (in a closet in the kitchen).

The **effluent flow meter** and the **UV filter** are located in the greenhouse along the line to the boosted storage tank. The effluent flow meter is a paddle flow meter. Flowing water spins a paddle and the meter generates the related flow volume. Water is disinfected as it flows through a cylinder containing two UV lightbulbs that are held within two quartz sleeves. UV light damages the DNA and RNA of cells and does not have residual toxicity, like chlorine.

### **Structural Design Problems**

Design compromises in two treatment phases, the clarifier and the wetland, may limit the performance of Oberlin’s living machine. An effective clarifier requires a balance between many design factors. A cone with a  $70^{\circ}$  slope allows sludge to slide down the sides of the tank



towards the central airlift; however, steepening the cone requires either a larger clarifier volume or shorter vertical walls. Tall vertical walls encourage settling as the water in the tank is forced to flow downward, whereas shorter vertical walls may not prevent the cross current that would pull water into the effluent weir before the sludge can settle. Because of volume and depth constraints, Oberlin's clarifier has a shallow  $45^\circ$  cone, and sludge accumulates on the sides of the cone instead of sliding towards the sludge collection airlift. Consequently, the clarifier must be closely attended, at least 3 times a week, and sludge must be manually pushed down the cone if necessary. If clarifier treatment is extremely poor, the cone-shaped tank could be replaced with a flat-bottomed tank with a collection arm that rotates around the tank floor, similar to the clarifiers in conventional treatment (Figures 3 and 7).

The living machine's small footprint constrained the wetland design. The wetland fills the entire greenhouse floor; however, water cannot flow through the wetland at an even rate because the four open tanks and a brick column cut through the gravel layer (Figure 16).

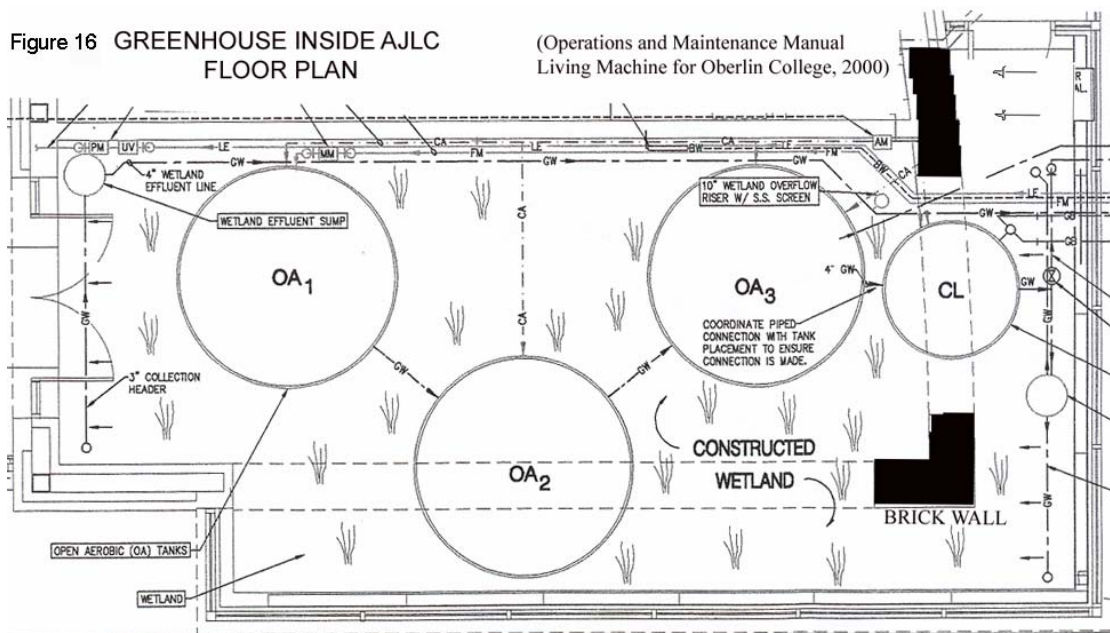

The wall near the north side of the distribution pipe also slows water flow, causing solids to settle prematurely. Water flows most freely along the same paths that operators will travel. As a result, the most strategically located plants will be trampled. Although the wetland is full of

water, influent could be following the path of least resistance, bypassing most of the vegetation. No other living machine incorporates structures that similarly obstruct wetland flow. No sufficient alternative space is available to allow the wetland floor design to be changed if poor treatment occurs.

The architect's greenhouse design also limits living machine performance because an unnecessary, purely aesthetic brick wall shades the tanks. Instead of observing the ecological design principle "Seek optimum levels for multiple functions, not the maximum or minimum level for any one" advocated by John Lyle, the architects wanted to know the minimum light level that plants require. Little data exists on the light requirements for the species in the machine, so the rough estimate that informed the architect's design may be too low. Many species in OA1 and OA3, the more shaded tanks, had to be transplanted to OA2.

The lowest point in the building, the elevator shaft, may also effect the living machine. If the building should flood, water would collect in the shaft, which contains a pump to take the water to the living machine. Operators should remember to check a device (located in front of this pump) that separates the elevator grease from the water.

### **Communication Problems**

Insufficient communication between Living Technologies, the city of Oberlin, Oberlin College, and the contractors resulted in design oversights that complicate the operating of the machine and compromise the safety of operators and city residents. The facilities coordinator at Oberlin College will address all of these design oversights as soon as possible.

A city water tap for spraying plants and is located 0.5 m above the wetland. The tap has double backflow preventors, but inspectors feared that sewage water could back-siphon through an attached hose and contaminate the city water supply. Before wastewater was allowed to flow into the greenhouse, the plumbers disconnected the direct city water line and installed a water holding tank in the equipment room 20 feet above the living machine. City water traverses an air gap between the influent pipe and the tank to prevent backflow. A float switch, triggered by low

water levels, sends city water into the tank. Because the hose does not receive pressurized city water, the elevated holding tank provides some hydraulic head for hose water, but not enough to spray insects off the plants. Water also flows by gravity from the elevated holding tank to provide make-up water for the water re-use holding tank. Because the line is not pressurized and the newly installed pipe takes ten 90° turns before it reaches the water re-use holding tank, make-up water only flows at 1 gall/min! Before treated water can be recycled back to the toilets, a pressure tank and pump should be installed in the equipment room to pressurize make-up water delivery.

The next problems requiring attention were along the pipe between the water re-use holding tank and the boosted storage tank. Because the line is pressurized, installation of a pressure release valve was necessary so that the components along the line, such as the paddle flow meter or the UV filter, could be removed for inspection or repair. A pressure switch had to be installed to control flow between the holding tank and the boosted storage tank. According to the original design, a low-pressure sensor in the boosted storage tanks cues the holding tank pumps to turn on, via the PLC. After filling the boosted storage tanks, holding tank pumps function until the low float in the holding tank switches them off. To avoid unnecessary pump wear when the boosted storage tank is already full, a pressure switch installed in the line turns the pumps on when pressure in the boosted storage tank falls below 30 psi and turns the pumps off when the pressure reaches 50 psi. Finally, a ball check valve was installed to stop backflow from the storage tank to the underground holding tank.

Plumbers failed to flush the grit out of the pipes before installing the UV filter. Then when the computer programmers were checking controls, they opened the flow through the delicate UV filter too quickly, which caused leakage of water and grit into the quartz tubes that hold the UV bulbs. The tubes and bulbs needed be cleaned and dried before the system could treat water.

While the machine is in start-up phase, city water flows directly into the boosted storage tank to flush the toilets. When machine water is ready to be recycled back to the toilets, the

connection between city water and the boosted storage tank will be cut and welded closed, making reconnection impossible (directly reconnecting to city water is illegal because no air gap exists). Therefore, all water entering the toilets will have to come through a portion of the living machine. City make-up water will fill the holding tank and be used to flush the toilets if the treatment fails; however, water from this holding tank must pass through the pipe that contains the UV filter, paddle flow meter, and the pressure sensor before it can enter the toilets. If components along this section of pipe malfunction, the toilets will not receive water. An emergency re-connect line (from the equipment room city water holding tank to the section of pipe downstream from the pressure sensor) is necessary before re-use can begin.

Air must circulate through the greenhouse to prevent the plants from overheating and to avoid insect infestations. Following Oberlin College's Value Engineering Assessment, operable ceiling windows were removed from the greenhouse design. Operable ceiling windows are necessary to promote convective air movements from the ground level windows upward.

Safety in addition to sanitary problems must be addressed. For example, water and electrical cords in the greenhouse pose the treat of electrocution. To stop an electrocution event, another person would have to run through the auditorium to the control room, use a key to open the circuit breaker box, and pull the main breaker. An emergency power shut-off switch must be installed in the greenhouse. Failure to install a sink inside the greenhouse also represents a health risk. Operators must walk to the public restrooms to wash their hands. Eventually, a lab with a sink will be constructed between the greenhouse and the atrium.

### **Start-up Procedure**

One expert from Living Technologies and 12 student operators completed the following steps to start-up the machine.

January 31, 2000

- filled open tanks with city water
- checked control room: switched off power to all four pump stations (pulled down the side levers on the four gray switch boxes, PS1 – PS4)
- checked equipment room located above the control room: switched on power to each blower and verified its vibration, and labeled blowers (CAB1, CAB2: 2 closed aerobic blowers; OAB1, OAB2, OAB3, OAB4: 4 open aerobic blowers)
- switched on 2 open aerobic blowers
- adjusted OA airflow valves on the greenhouse wall to allow gentle mixing
- studied OA2 diffuser assembly: closed airflow to OA2, snapped the black clip off the vertical pipe on the left, unscrewed the central connector - took care not to lose the rubber O-ring, pulled the L-shaped assembly out of the water
- prepared plant racks: used cable ties to strap mesh plastic trays to the floating plant racks, placed an inverted, bottomless peat pot in the center of each tray (the trays prevent the peat pots from sliding into the water)

February 2, 2000

- placed plants inside peat pots, threaded roots through the racks (A plant will survive if only one large root reaches the water; therefore, pushing the entire root mass through the racks is unnecessary. Removing most shoots reduces transplant stress). The plants came from the South Burlington Living Machine, in Burlington, VT, where the botanist evaluated 250 plant species for the following traits: large root surface area; long, dangling roots; year-round growth; rapid growth; resistance to pests and disease; low maintenance; aesthetic appeal; and the capacity to thrive in concentrated wastewater. The tropical and native plants selected for the Oberlin College Living Machine are on Living Technologies' list of best performing plants (See Appendix A).
- inoculated OA1 water with 2 cups settled sludge and 2 cups of a root mass covered with snails and other grazers.

- added soil from the potted willows to open tanks.

Two *Thalia geniculata* plants and two *Salix* spp. plants died. One-fifth of the plants placed in OA1 and OA3 needed more sunlight and were moved into OA2. An additional planting occurred on March 21, 2000. (See Appendix B, a map of the plant species in the greenhouse on April 14, 2000).

Failure to inform Living Technologies that the Programmable Logic Controller (PLC) touch pad (to control the pumps, the airlifts, the flow meters, and the pressure sensor) had not been installed delayed the start-up procedure by one week. Commands needed to be entered into the Siemens program, which is accessed using a laptop.

February 14, 2000

- directed wastewater flow into the living machine: switched knife valves (pushed down sewage by-pass valve located closer to the building, opened AN1 valve)
- turned on pump stations 1 and 2: pulled up lever on switch box to engage power, set knob near bottom of the box to “auto”
- aerated CA tanks: adjusted CA1 and CA2 airflow meters (located in the control room), observed turbidity in tanks, set minimum airflow for mixing (The head operator from Living Technologies set both meters at 2.0 cfm even though the Operations and Maintenance Manual suggests 1.0 cfm in CA1 and 0.75 in CA2.)
- inoculated CA2 with 1.5 pounds of freeze-dried bacteria (3 half-pound packets)
- added 0.6kg of cow feed to CA2
- added 0.5 lb. freeze-dried bacteria and 0.6 kg cow feed to the OA tanks

February 15, 2000

- adjusted the three recycle flows (clarifier scum to AN1, clarifier settled solids to CA1, and OA3 mixed liquor to CA1): used the PLC to switch on each airlift, turned ball valve to increase airflow until waste begins to splash out of the top of the airlift pipe. Set the recycle frequency and duration with the PLC in the Point ->Command ->Value menu. The path Point -> Monitor -> Listpoints will display the specific point name for each operation. “Shift

3” commands the PLC to return to the default menu. After changing a value, follow the path Point -> Operation -> Priority -> None to return operating control to the PLC.

February 16, 2000

- added 4 gallons of surface water and floating detritus from Plum Creek to OA3, the least stressful habitat for freshwater organisms.
- added pint of karo syrup, half a gallon of whole milk, and leaf mulch (full of anaerobic bacteria) to AN1. The anaerobic digester may take several months to start-up. Aerobic bacteria must deplete the oxygen in the digester before the anaerobic population can grow. Anaerobic respiration is inefficient in the sense that only 2 ATP per molecule glucose contribute to population growth, compared to the 22 ATP involved in aerobic population growth. The low water temperature ( $>10^{\circ}\text{C}$ ) in the winter also slows the growth of anaerobic bacteria.

February 17, 2000

- added 1000 gallons of 5000 mg/l MLSS activated sludge to CA1. (The expert from Living Technologies did not follow the Operations and Maintenance Manual, which states that “if TSS concentration is below 500mg/l, influent flow should be gradually introduced to the system at an approximate rate of 20% a day until the full design flow is reached.”)

Because influent flow is lower than required by the design, student operators added 6 kg of cow feed to CA1 every other day for two weeks. One kilogram of cow feed represents 1.5 kg of BOD (Operations and Maintenance Manual, 2000). A total of 40.4 kg of cow feed was added to the system, but adding cow feed did not drop the DO. All tanks had DO levels above 8.0 mg/l instead of 0.5 – 4.0 mg/l.

March 11, 2000

- added 4L of molasses (with a BOD of 500,000 mg/l) to CA1.

March 13, 2000

- added 6L of molasses and 4.5 kg dog food to CA1.
- added 661 g of Miracle Grow to the open tanks to give plants more nitrogen.

Last two weeks of March

- added a total of 4.5 kg of dog food, one liter of spoiled milk, and 23.5 gallons of food waste to CA2, but the D.O. did not drop below 5.0 mg/l in any aerobic tank.

Until the root systems develop, the living machine operates like a conventional activated sludge plant. The floc-forming microorganisms must be supplied with an adequate amount of food so they dominate in the CA tanks rather than single-celled and filamentous bacteria.

During the first few months of operation, the digesters will not function anaerobically; therefore, wastewater entering CA1 will not create the anoxic conditions that control filamentous bacteria. Also, the small population of grazers on the undeveloped root systems cannot control the single-celled bacteria population. Encouraging the growth of floc-forming bacteria is only strategy to keep the start-up system under control. If DO levels remain near saturation, the polysaccharide matrix surrounding the flocs will mineralize and the resulting pin floc will not settle.

March 28, 2000

- calibrated the recycle flows using the following procedure: bypassed the influent to sewer, recorded the time and influent totalizer volume, returned 12 to 24 hours later, recorded the time and the influent totalizer volume, redirected flow into the system, and calculated recycle flow per day. Any change in airflow, airlift frequency, or airlift duration necessitates a recycle calibration. The recycle flow (set at approximately 3 times the influent flow) was about 2000 gpd, and daily flow was 200 – 500 gpd, instead of 2470 gpd.

March 29, 2000

- halved the duration of the recycle flow between OA3 to CA1 (via the PLC). The reduced volume of aerated water (1000 gpd) flowing into CA1 did not lower its DO level.

Second and third weeks of April

- added 4 to 15 gallons of food waste to CA2 daily. Food waste is added to CA2 because the hatches covering the AN tanks and CA1 are bolted closed.

April 21, 2000

The D.O. levels have fallen below 0.5 mg/l, but since food waste was added to CA2



instead of CA1, filamentous bacteria were abundant. The clarifier supernatant was cloudy, which indicates poor wastewater treatment. Settleable solids volume (SSV) in OA3 was high, approaching 35%.

Week of April 25, 2000

- unbolted the hatch to CA1 and added food waste daily

Week of May 1, 2000

- unbolted the hatch to AN1 and added food waste daily. turned down clarifier solids airlift so that solids would accumulate to 18 inches. Because only a few inches of solids had been settling on the clarifier bottom, supernatant, which contained filamentous bacteria, was also being recycled back to CA1; therefore, floc-formers were competing for food and losing to the filamentous bacteria (some species of filamentous bacteria are also facultative aerobes). Turned off OA3 recycle for a week to prevent all filamentous bacteria from entering CA1. Forgot to increase air flow to CA1, so that bacteria could respire in the absence of  $\text{NO}_3$  from OA3.
- Checked the UV filter. Pulled the quartz tubes out of the UV cylinder without twisting them, and wiped off grit with a soft cloth.

Week of May 8, 2000

- Added food waste to CA1 and AN1 on alternate days because food was accumulating in AN1 and DO levels were rising.

Once extensive root systems develop, operation should run smoothly despite the low influent BOD. The grazing community, not the activated sludge, will remove most of the waste. Unless Oberlin's Living Machine receives a more concentrated waste stream in the future, the entire system may function as low-flow artificial wetland with weekly additions of 25 gallons of compost. When adding large quantities of food waste, the food to microorganism ratio must be considered (see previous section on Conventional Secondary Treatment, p.9).

## Monitoring

The living machine must be monitored at least 3 days a week to ensure its successful operation. Also, if Oberlin College plans to apply for a discharge permit, the EPA must evaluate our process control monitoring program. Monitoring involves observation and analysis.

A quick assessment of the clarity of the clarifier water will indicate whether the system is working properly. Clear water indicates that single-celled and filamentous bacteria are under control. A sludge judge, which is a long graduated cylinder, is used daily to measuring the settled solids at apex of the clarifier cone and on its walls. Sludge removal must be modified by increasing airflow or changing the flow intervals via the PLC if the following conditions occur: solids build up more than 2 ft, solids are anaerobic (black and odorous), or floating solids accumulate.

Each day the solid content in water must be determined with samples taken from OA3. This test is conducted using a Settleometer, which is a 1000 ml graduated cylinder. The sample is allowed to settle for 30 minutes, after which the settleable solids volume (SSV) is determined and the clarity of the supernatant observed. To prevent its discoloration, the Settleometer must be thoroughly cleaned after each use and stored in a dark place.

Electronic probes are used to monitor DO and temperature, pH, TSS, and ORP. Testing should progress from downstream to upstream to prevent contamination. The DO probe must be calibrated before every use. Because the probe consumes oxygen in the process of measurement, the probe must be moved through the water column at 1 ft/sec (moving the probe at variable speeds affects the precision of the DO measurement). One operator should be trained to change the probe's membrane biweekly. After use, the probe and its storage compartment must be rinsed with de-ionized water. Daily pH readings should be taken from AN1, CA2, OA1, and the clarifier. Following each use, the pH meter and its storage cap should be rinsed with tap rather than de-ionized water. Both the DO and pH probes must be kept moist. The TSS probe is used in OA3 and the clarifier. The probe uses optical density to calculate suspended solids. Monthly probe calibration involves analyzing a grab sample from OA3 (drying the filtrate from a

measured sample volume) and entering the result into the probe. ORP, oxidation-reduction potential, may be monitored to track the establishment of anaerobic or anoxic conditions in the AN tanks and in CA1; however, if an ORP probe is unavailable, DO readings will suffice.

A composite sample (several samples collected during a specified time period) is used to test total nitrogen (TN), nitrate, phosphate, and BOD. A mass spectrophotometer is used to determine nitrate and phosphate concentrations in OA1 and the wetland effluent sump weekly and TN concentrations in AN1 monthly. Living Technologies suggests monthly influent and effluent BOD tests, but BOD should be monitored in all tanks because Oberlin's living machine has research applications. The standard method for determining BOD<sub>5</sub> involves measuring DO before and after 5 days at 20°C.

The sludge from the Settleometer is observed daily under the microscope at 10X to monitor the abundances of filamentous bacteria, stalked ciliated protozoans, free-swimming ciliated protozoans, flagellated protozoans, rotifers, and nematodes. Microcrustaceans, such as copapods, are observed weekly by placing a grab sample from the clarifier in a petri dish. A grab sample from the boosted storage re-use tank should be sent to a lab for a monthly fecal coliform count.

The influent and effluent totalizer volumes should be recorded at a set time each day. The number of blowers turned on, the total air pressure generated by the blowers, and the airflow to each diffuser should also be recorded.

## **Maintenance**

Daily operations involve removing floating matter from the standpipe in the clarifier's influent header. Floating solids inside the effluent weir should be broken up, and the weir should be scrubbed clean. The clarifier should be swept if more than a foot of sludge has accumulated on its walls. Daily removal of pests, disease, and decay maintains plants. During extremely hot summers, the shoots may need to be misted daily. (See Appendix C for common problems and solutions.)

The sides of the tanks, the windowsills, the door handles, the gloves, and the lab table are washed with soapy water weekly to maintain sanitary conditions. The knife and scissors should be washed in hot soapy water.

Monthly, each OA diffuser assembly should be removed and the solids should be wiped off the its membrane. The clarifier header assembly should also be removed and cleaned. Scum should be removed from the wetland effluent sump.

Long-term maintenance involves changing the UV light bulb and its O-rings twice a year. PS3 and PS4 should be turned off, and a plumber or mechanical expert must be present to monitor the order in which valves are opened (the pressure release valve and then the drain on the bottom of the UV cylinder) or closed. After cleaning the quartz sleeves and changing the bulbs, the ends of the bulbs need to be sealed with new O-rings and teflon tape. Return flow through the UV filter by turning the upstream ball valve very slowly. Pump AN1 when solids accumulate to 3 ft or the floating scum layer reaches 2 feet thick. When a flow meter LCD is almost full, the total volume is recorded and the meter zeroed. The end caps on the wetland distribution and collection pipes are removable to clean the pipes with a high-pressure water spray. After 50 years, decaying roots will clog the gravel, and wetland should be reconstructed.

#### **Chapter 4: Research Opportunities**

The absence of dual test tracks limits the research potential of the living machine. A Living Machine is an educational tool in the AJLC, and students gain experience studying its life, but without a track to serve as the control while the other track is manipulated, experiments that modify sewage treatment cannot be conducted.

Students should consider investigating the following topics:

- Survey microbial communities – The Living Technologies expert says that no one has studied microbial succession in the root zones. Another new research area involves studying the microbial communities that each plant species attracts and trying to discover microbe/plant interactions. Living Technologies would like to see this research published.

(See document in the Environmental Studied Information Center: suggested methods and materials for future research (David Austin 2000), bibliography, and a microbial survey started by Sarah Eastman, OC'00 and Varuni Tiruchelvam OC'00)

- Calculate root surface area – Develop a method for measuring root surface area. The student would be conducting useful research that Living Technologies would like to see published. During his winter term work at the South Burlington Living Machine, Eric Lohan, OC'98, began to develop a method involving computer models. He planned to take a photograph of the root mass by bisecting the mass with a plate. Then he could make a computer model to calculate surface area.
- Biomass – Document plant growth and calculate the amount of plant biomass removed from the system (started by Elizabeth Tong, OC'01)
- Systems metabolism – Professor John Petersen has developed a method to measure in-situ systems metabolism. Readings from hanging DO probe assemblies (constructed by Professor Petersen, Alexander Maly, OC'02, James McConaghie, OC'03, and Lucian Eisenhauer, OC'03) will enter a data logger. When aeration is temporarily shut off, the decrease in DO corresponds to aerobic metabolism.
- Cost analysis – Study the cost effectiveness of treatment with the living machine. Investigate the initial construction costs and calculate long term costs, such as the power demand of the blowers and pumps. Make comparisons to conventional treatment, which devotes 1/3 of its costs to sludge disposal.
- Research marketability of cut flowers – The South Burlington Living Machine could cover its annual operating costs, \$80,000, by growing a monoculture of calla lilies, *Zantedeschia aethiopica*, which have a retail price of \$7/stem. Research the cut flower industry (are flowers being grown in sewage and how are they cleaned before sale?), and conduct experiments to monitor pathogens on cut stems.
- Study unique plant biology in the machine – Plant growth in the machine differs from natural patterns. *Caltha palustris* grows and flowers throughout the year! Variegated *Hibiscus*

*moscheutos* survives while its non-variegated form dies, but *Oenanthe javanica* outcompetes its variegated form.

#### Literature Cited

Austin, David. 2000. Four Training Sessions: February – May, provided by Living Technologies, Inc. as part of the system start-up procedure.

Crites, Ronald. W, and George Tchobanoglous. 1998. Small and Decentralized Wastewater Management Systems. WCB/McGraw Hill; Boston.

Hammer, M. and M. Hammer, jr. 1996. Water and Wastewater Technology. 3rd ed. Prentice Hall, Inc; Columbus.

Lyle, John. 1994. Regenerative Design for Sustainable Development. John Wiley and Sons, Inc.; New York, p. 40.

Miller, G. Tyler. 1998. Living in the Environment. Wadsworth Publishing Company; New York.

Operations and Maintenance Manual, A Living Machine for Oberlin College. 2000. Living Technologies, Inc.; Burlington.

Platt, Anne. 1996. Water-borne killers. Worldwatch 9(2): 28-35.

United Nations Environment Programme. 1991. Freshwater Pollution. UNEP; Nairobi.

United Nations Environment Programme. 1994. The Pollution of Lakes and Reservoirs.  
UNEP; Nairobi.

Young, G., J. Dodge, and J. Rodda. 1994. Global Water Resource Issues.  
Cambridge University Press; New York.